



MS

CUSTOM

CUSTOM CYCLE COLLECTION

HILLBRICK

CUSTOM CYCLE & SPORTSWEAR



Your purchase will help people living with multiple sclerosis get the vital support they need to meet their goals and live well, and ensure that no one has to face MS alone.

Whether you are a team of 5 or 50, you too can *#Ride2FightMS* in your very own CUSTOM TEAM KIT!

We have seen some amazing (and some crazy) design in years past. It all adds to the team's comradery on event day, and creates an excellent opportunity for sponsorship from supporters, local businesses and brands, which can further add to your team's fundraising.

And when you order with MS Custom, you get....

FREE Design Support
Online Team Store

NO Minimum Order
Setup Fees

“It’s been a crucial element to our identity as most people will associate our colours (green, black and white) with our team. Also, it empowers the team as they feel part of something big...because they are! It also acts as an effective vessel to showcase our generous sponsors who get behind us every year.”

Kim Nguyen, president of the Soft Cogs, recognises this opportunity and has leveraged this to help promote his team’s supporters, giving them exposure to thousands of cyclists and hundreds of spectators on event day. Not to mention the recognition they get on the training rides.



PAST CUSTOMERS

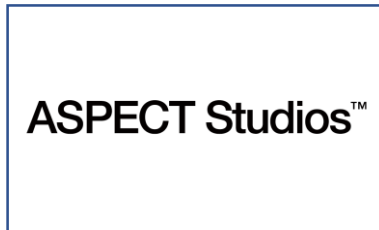



Have a design in mind or would you like assistance creating a design? Our graphic designer will ensure you're in safe hands.

All we need from you is an idea or concept.

Tell us with words, sketches, logos and/or photos what your vision is, and our designer will work with you to create your own custom design.



Need some inspiration? Have a look through our [Sample Design Gallery](#).

A top-down view of a person's hands holding a smartphone. The phone's screen is white and displays the text "REQUEST A QUOTE" in a bold, blue, sans-serif font. The text is underlined. The background is a wooden desk. To the top left is a white coffee cup on a saucer. To the right is a silver laptop keyboard. Below the phone is a grey spiral notebook with a yellow pencil and a pair of black-rimmed glasses.

REQUEST A QUOTE



PRODUCT RANGE
CUSTOM CYCLING COLLECTION

PRODUCT RANGE

CLASSIC CYCLING JERSEY



**BODY
CONTOURED**



BREATHABLE



COMFORT



DURABLE



LIGHTWEIGHT



**MOISTURE
WICKING**



SEALED SEAMS



**50+
UV
SUN GUARD**



FABRIC: 50% CoolDry | 50% Polyester

SIZES: Men's: XS – 4XL | Women's: XS – 4XL | Kid's: 4K – 16K

MS
CUSTOM

PRODUCT RANGE

SPORTIVE CYCLING JERSEY



**BODY
CONTOURED**



BREATHABLE



COMFORT



DURABLE



LIGHTWEIGHT



**MOISTURE
WICKING**



SEALED SEAMS



**50+
UV
SUN GUARD**



FABRIC: 92% Polyester | 8% Elastane

SIZES: Men's: XS – 4XL | Women's: XS – 4XL

MS
CUSTOM

PRODUCT RANGE CLASSIC BIB SHORTS



**BODY
CONTOURED**



BREATHABLE



COMFORT



DURABLE



LIGHTWEIGHT



**MOISTURE
WICKING**



SEALED SEAMS



**50+
UV
SUN GUARD**



FABRIC: 82% Lycra | 18% Spandex

SIZES: Men's: XS – 4XL | Women's: XS – 2XL | Kid's: 4K – 16K



PRODUCT RANGE SPORTIVE BIB SHORTS



**BODY
CONTOURED**



BREATHABLE



COMFORT



DURABLE



LIGHTWEIGHT



**MOISTURE
WICKING**



SEALED SEAMS



**50+
UV
SUN GUARD**



FABRIC: 82% Lycra | 18% Spandex

SIZES: Men's: XS – 4XL | Women's: XS – 4XL

MS
CUSTOM

PRODUCT RANGE CLASSIC WIND VEST



COMFORT



DURABLE



LIGHTWEIGHT



PACKABLE



SEALED SEAMS



SUN GUARD



WATER
RESISTANT



WINDPROOF



FABRIC: 100% Polyester

SIZES: Unisex: XS – 5XL

MS
CUSTOM

PRODUCT RANGE THERMAL JACKET



FABRIC: Main Body - Windtex | Auxiliary – 100% Polyester (Fleece Thermal)

SIZES: Unisex: XS – 3XL



PRODUCT RANGE

CLASSIC ARM WARMERS



FABRIC: 82% Lycra | 18% Spandex

SIZES: Unisex: XS – 2XL



PRODUCT RANGE

CLASSIC LEG WARMERS



**BODY
CONTOURED**



BREATHABLE



COMFORT



DURABLE



LIGHTWEIGHT



**MOISTURE
WICKING**



PACKABLE



SEALED SEAMS



**50+
UV
SUN GUARD**



WINDPROOF



FABRIC: 82% Lycra | 18% Spandex

SIZES: Unisex: S – 2XL

MS
CUSTOM



SIZING GUIDE

CUSTOM CYCLING COLLECTION

MEN'S SIZING CHART

CLASSIC JERSEY

		XS	S	M	L	XL	2XL	3XL	4XL
Front Length	A	47	49	51	53	55	57	59	61
Back Length	B	61	63	65	67	69	71	73	75
Half Chest	C	46	48	50	52	54	56	58	60
Bottom Width	D	38	40	42	44	46	48	50	52
Sleeve Length	F	33	34	35	36	37	38	39	40
Sleeve Cuff	G	12	12.5	13	13.5	14	14.5	15	15.5
Back Collar Width	I	15	15.5	16	16.5	17	17.5	18	18.5
Collar Height	L	4	4	4	4	4	4	4	4

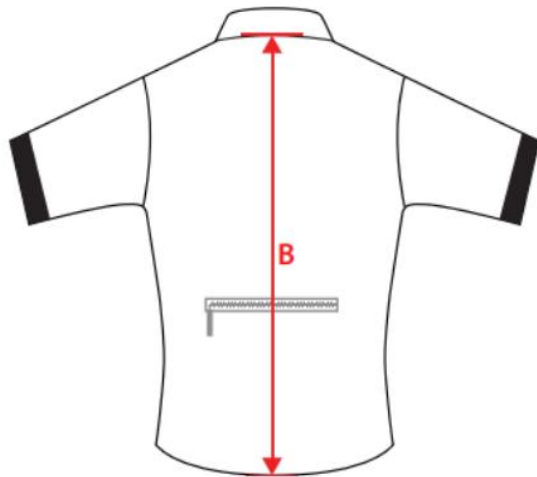
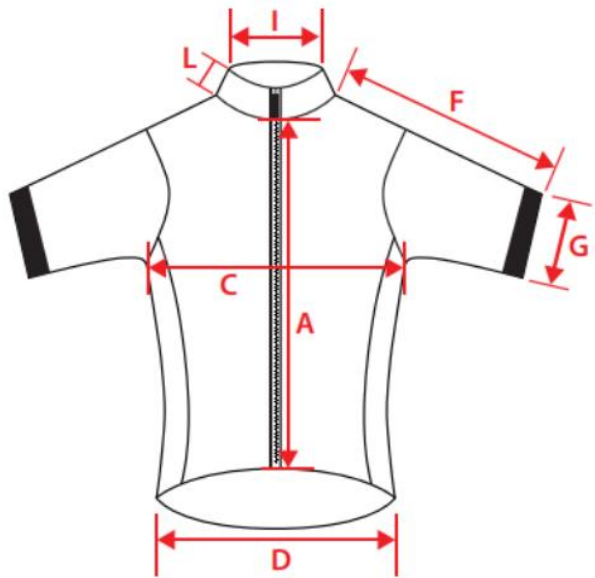

WOMEN'S SIZING CHART CLASSIC JERSEY

		XS	S	M	L	XL	2XL	3XL	4XL
Front Length	A	48	50	52	54	56	58	60	62
Back Length	B	60	62	64	66	68	70	72	74
Half Chest	C	44	46	48	50	52	54	56	58
Bottom Width	D	30	32	34	36	38	40	42	44
Sleeve Length	F	31	32	33	34	35	36	37	38
Sleeve Cuff	G	11.5	12	12.5	13	13.5	14	14.5	15
Back Collar Width	I	15.5	16	16.5	17	17.5	18	18.5	19
Collar Height	L	4	4	4	4	4	4	4	4

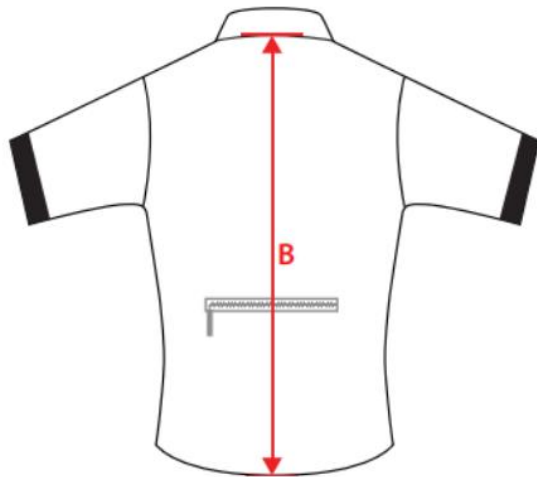
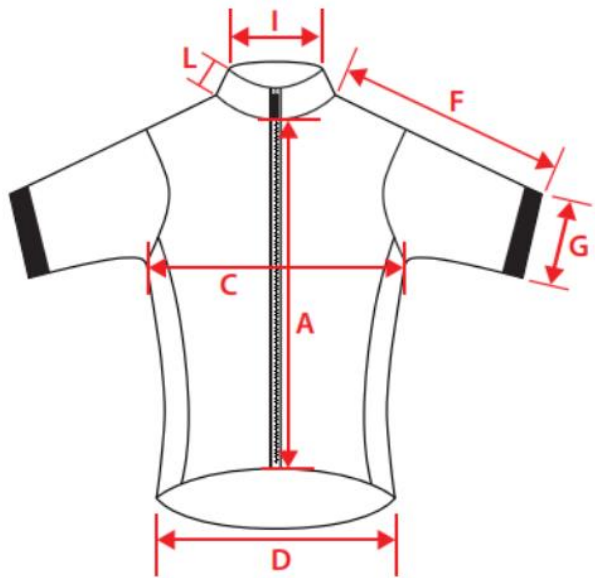

KID'S SIZING CHART

CLASSIC JERSEY

		4K	6K	8K	10K	12K	14K	16K
Front Length	A	39	41	43	45	47	49	51
Back Length	B	50	52	54	56	58	60	62
Half Chest	C	35	37	39	41	43	45	47
Bottom Width	D	22	24	26	28	30	32	34
Sleeve Length	F	26	27.5	29	30.5	32	33.5	35
Sleeve Cuff	G	9.5	10	10.5	11	11.5	12	13
Back Collar Width	I	10	10.5	11	11.5	12	12.5	13
Collar Height	L	3	3	3	3	3	3	3

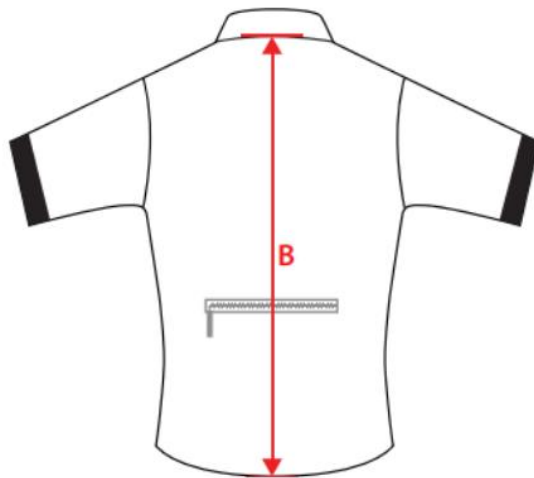
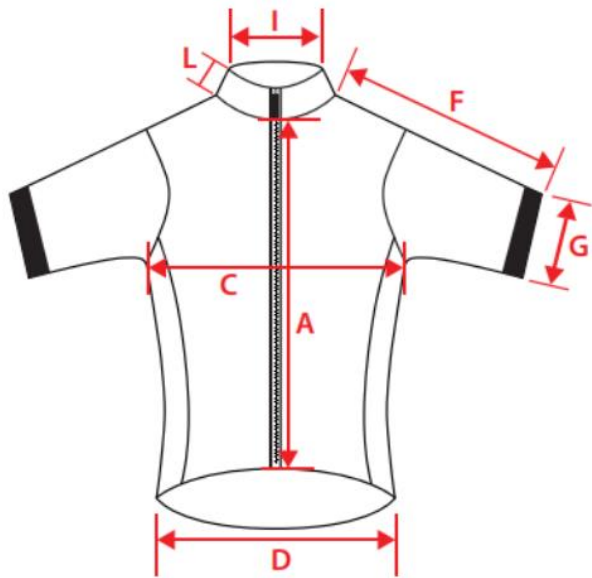

MEN'S SIZING CHART

SPORTIVE JERSEY

		XS	S	M	L	XL	2XL	3XL	4XL
Front Length	A	53	55	57	59	61	63	65	67
Back Length	B	68	70	72	74	76	78	80	82
Half Chest	C	44	46	48	50	52	54	56	58
Bottom Width	D	33	35	37	39	41	43	45	47
Sleeve Length	F	34	36	38	40	42	44	46	48
Sleeve Cuff	G	11	11	12	12	12	13	13	13
Back Collar Width	I	11	13	15	17	19	21	23	25
Collar Height	L	4	4	4	4	4	4	4	4

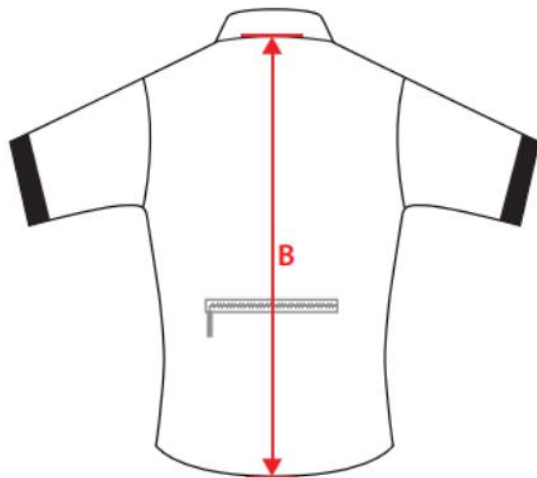
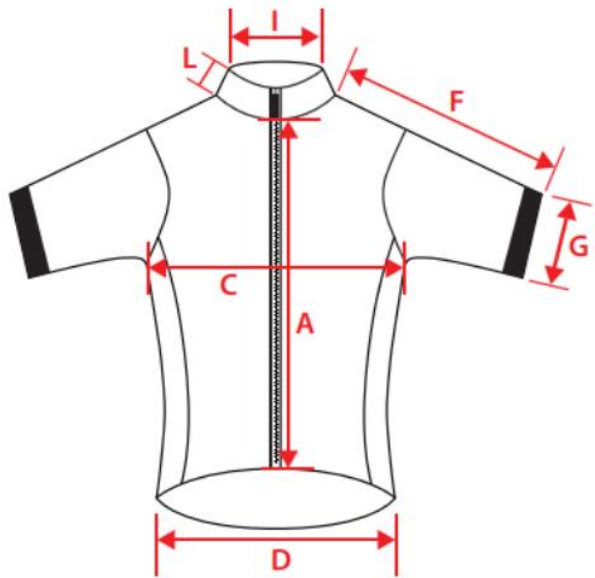

WOMENH'S SIZING CHART

SPORTIVE JERSEY



		XS	S	M	L	XL	2XL	3XL	4XL
Front Length	A	51	53	55	57	59	61	63	65
Back Length	B	66	68	70	72	74	76	78	80
Half Chest	C	42	44	46	48	50	52	54	56
Bottom Width	D	31	33	35	37	39	41	43	45
Sleeve Length	F	32	34	36	38	40	42	44	46
Sleeve Cuff	G	11	11	11	12	12	12	13	13
Back Collar Width	I	10	12	14	16	18	20	22	24
Collar Height	L	4	4	4	4	4	4	4	4

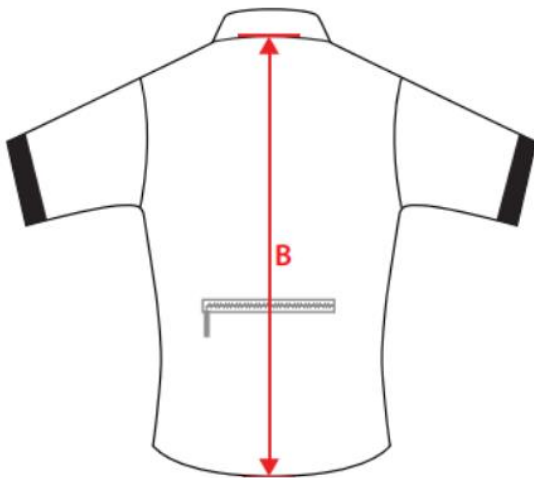
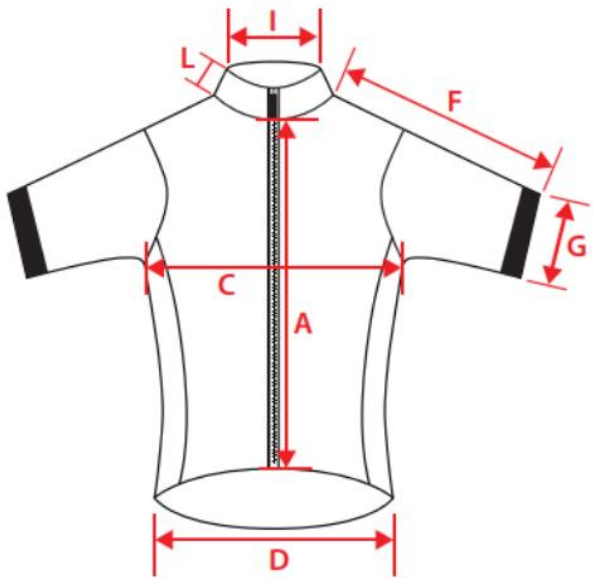

MEN'S SIZING CHART

CLASSIC BIB SHORTS

		XS	S	M	L	XL	2XL	3XL	4XL
Waist	A	28	30	32	34	36	38	40	42
Hips	B	36	38	40	42	44	46	48	50
Inseam	C	21	22	23	24	25	26	27	28
Armhole	E	30	31	32	33	34	35	36	38
Overall Length	H	77.5	80	82.5	85	87.5	90	92.5	95
Leg Cuff	J	19.5	20	20.5	21	21.5	22	22.5	23

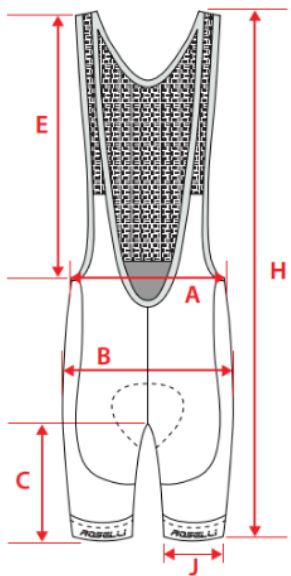

WOMEN'S SIZING CHART

CLASSIC BIB SHORTS



		XS	S	M	L	XL	2XL
Waist	A	27	29	31	33	35	37
Hips	B	33	35.5	38	40.5	43	45.5
Inseam	C	20	21	22	23	24	25
Armhole	E	35.5	36.5	37.5	38.5	39.5	40.5
Overall Length	H	80	83	86	89	92	95
Leg Cuff	J	18.5	19.5	20.5	21.5	22.5	23.5

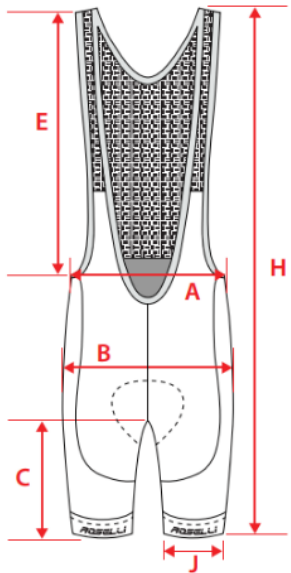

KID'S SIZING CHART

CLASSIC BIB SHORTS

		4K	6K	8K	10K	12K	14K	16K
Waist	A	20	22	24	26	28	30	32
Hips	B	21	23	25	27	29	31	33
Inseam	C	14.5	15	15.5	16	16.5	17	17.5
Armhole	E	23	25	27	29	31	33	35
Overall Length	H	54	57	60	63	66	69	71
Leg Cuff	J	12	13	14	15	16	17	18

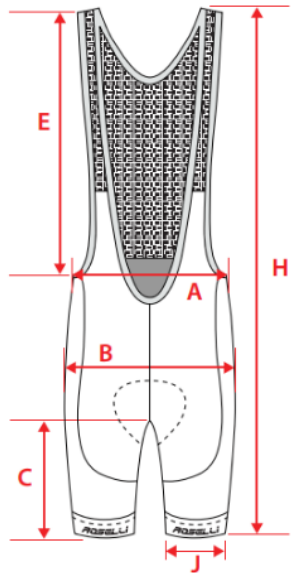

MEN'S SIZING CHART

SPORTIVE BIB SHORTS



		XS	S	M	L	XL	2XL	3XL	4XL
Waist	A	29	31	33	35	37	39	41	43
Hips	B	31	33	35	37	39	41	43	45
Inseam	C	21	22	23	24	25	26	27	28
Armhole	E	34	36	38	40	42	44	46	48
Overall Length	H	78	80	82	84	86	88	90	92
Leg Cuff	J	17	18	19	20	21	22	23	24

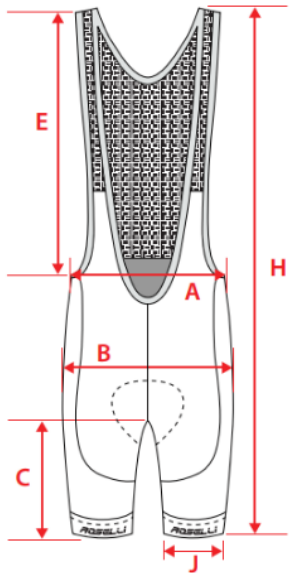

WOMEN'S SIZING CHART

SPORTIVE BIB SHORTS



		XS	S	M	L	XL	2XL	3XL	4XL
Waist	A	27	29	31	33	35	37	39	41
Hips	B	29	31	33	35	37	39	41	43
Inseam	C	20	21	22	23	24	25	26	27
Armhole	E	32	34	36	38	40	42	44	46
Overall Length	H	76	78	80	82	84	86	88	90
Leg Cuff	J	16	17	18	19	20	21	22	23

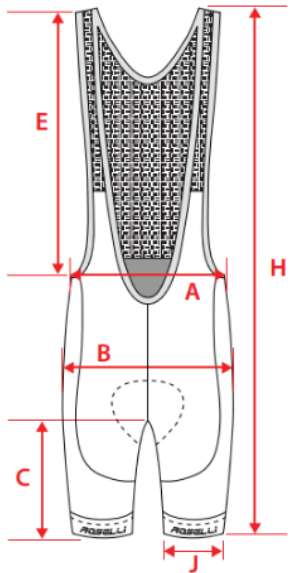

UNISEX SIZING CHART

CLASSIC WIND VEST

		XS	S	M	L	XL	2XL	3XL	4XL	5XL
Front Length	A	47	49	51	53	55	57	59	61	63
Back Length	B	69	71	73	75	77	79	81	83	85
Half Chest	C	50	52	54	56	58	60	62	64	66
Bottom Width	D	38	40	42	44	46	48	50	52	54
Armhole	E	24	25	26	27	28	29	30	31	32
Back Collar Width	I	17	17.5	18	18.5	19	19.5	20	20.5	21
Collar Height	L	6.5	6.5	6.5	6.5	6.5	6.5	6.5	6.5	6.5

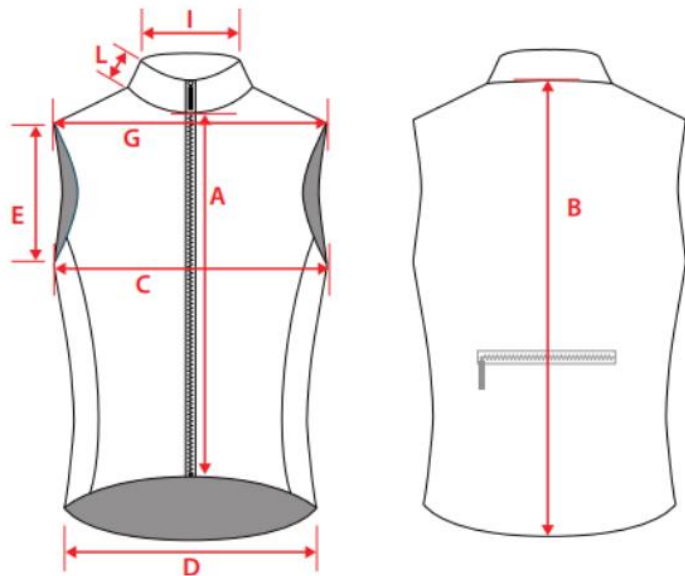

UNISEX SIZING CHART

THERMAL JACKET

		XS	S	M	L	XL	2XL	3XL
Front Length	A	52	54	56	58	60	62	64
Back Length	B	64	66	68	70	72	74	76
Half Chest	C	51	53	55	57	59	61	63
Bottom Width	D	39	41	43	45	47	49	51
Sleeve Length	F	76.5	78	79.5	81	82.5	84	85.5
Sleeve Cuff	G	10	10.5	11	11.5	12	12.5	13
Back Collar Width	I	17	17.5	18	18.5	19	19.5	20
Collar Height	L	7.5	7.5	7.5	7.5	7.5	7.5	7.5

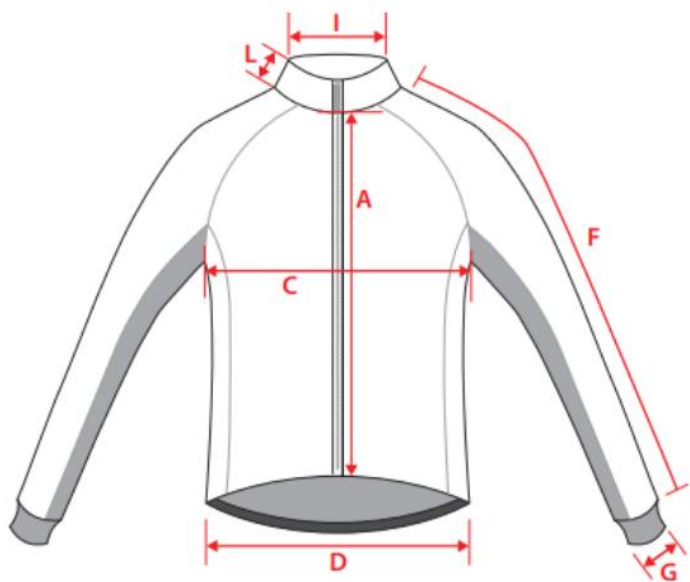

UNISEX SIZING CHART

CLASSIC ARM WARMERS



		XS	S	M	L	XL	2XL
Total Length	A	38	40	42	44	46	48
Half Bottom	D	7.5	8	8.5	9	9.5	10
Half Top	K	12	12.5	13	13.5	14	14.5

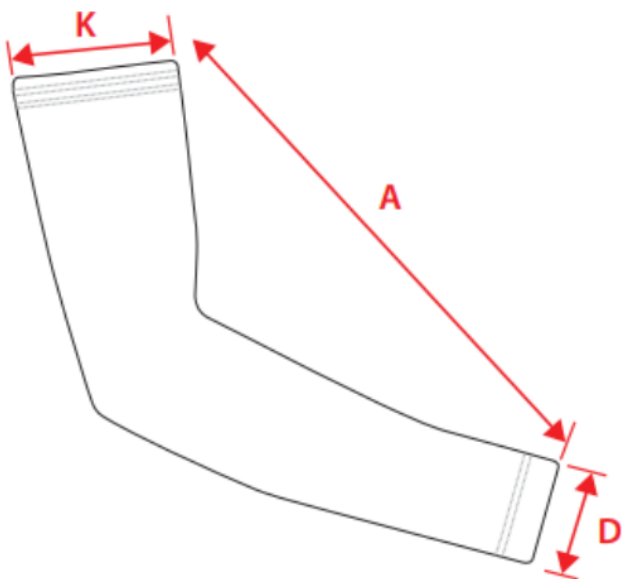

UNISEX SIZING CHART CLASSIC LEG WARMERS

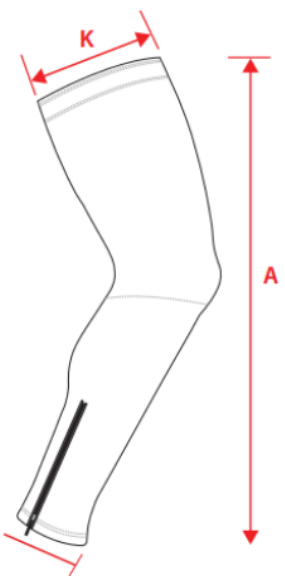

		S	M	L	XL	2XL
Total Length	A	65	67	69	71	73
Half Bottom	D	20	22	24	26	28
Half Top	K	35	37	39	41	43



DESIGN TEMPLATES
CUSTOM CYCLING COLLECTION

DESIGN TEMPLATE SHORT SLEEVE JERSEY

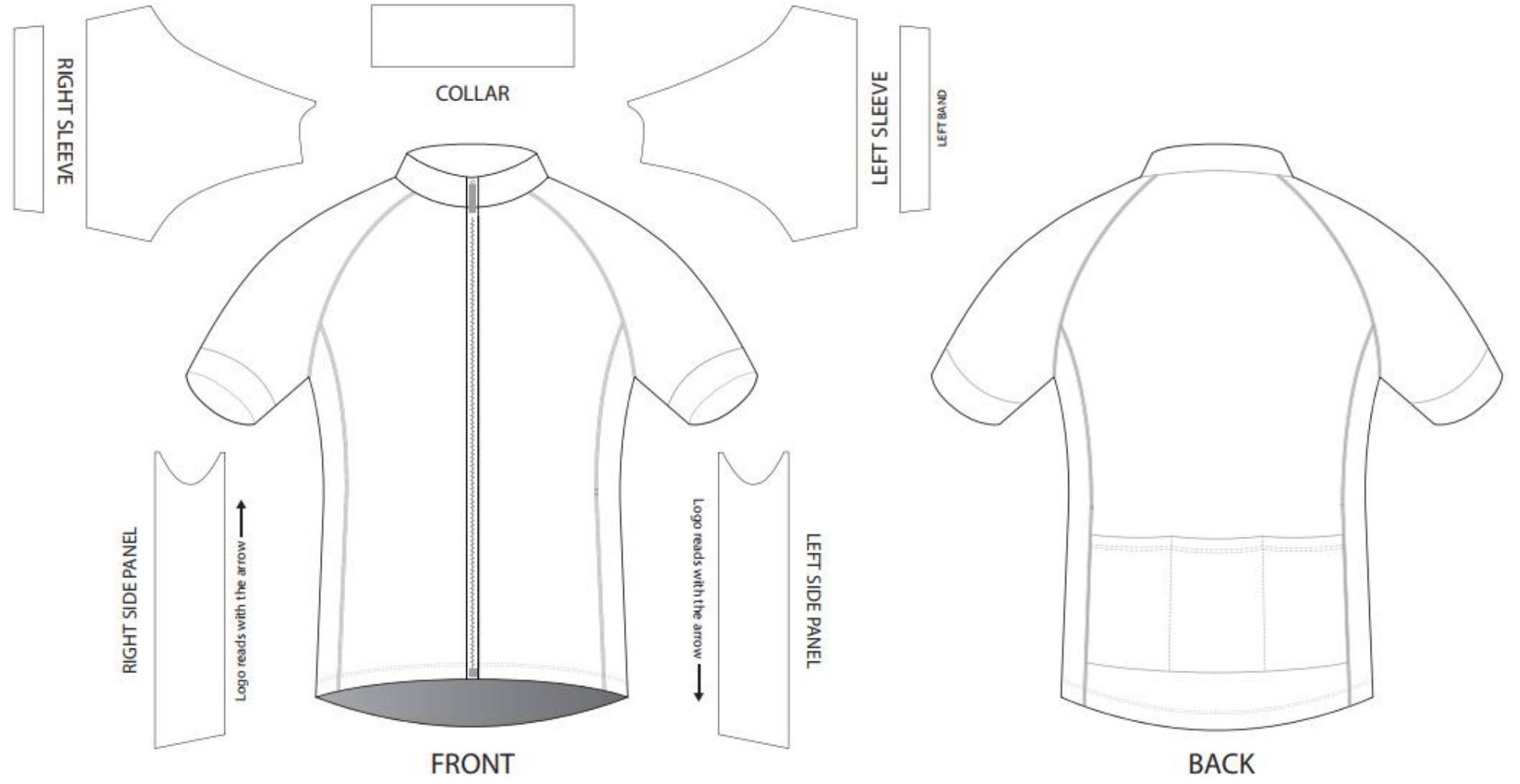

DESIGN TEMPLATE LONG SLEEVE JERSEY

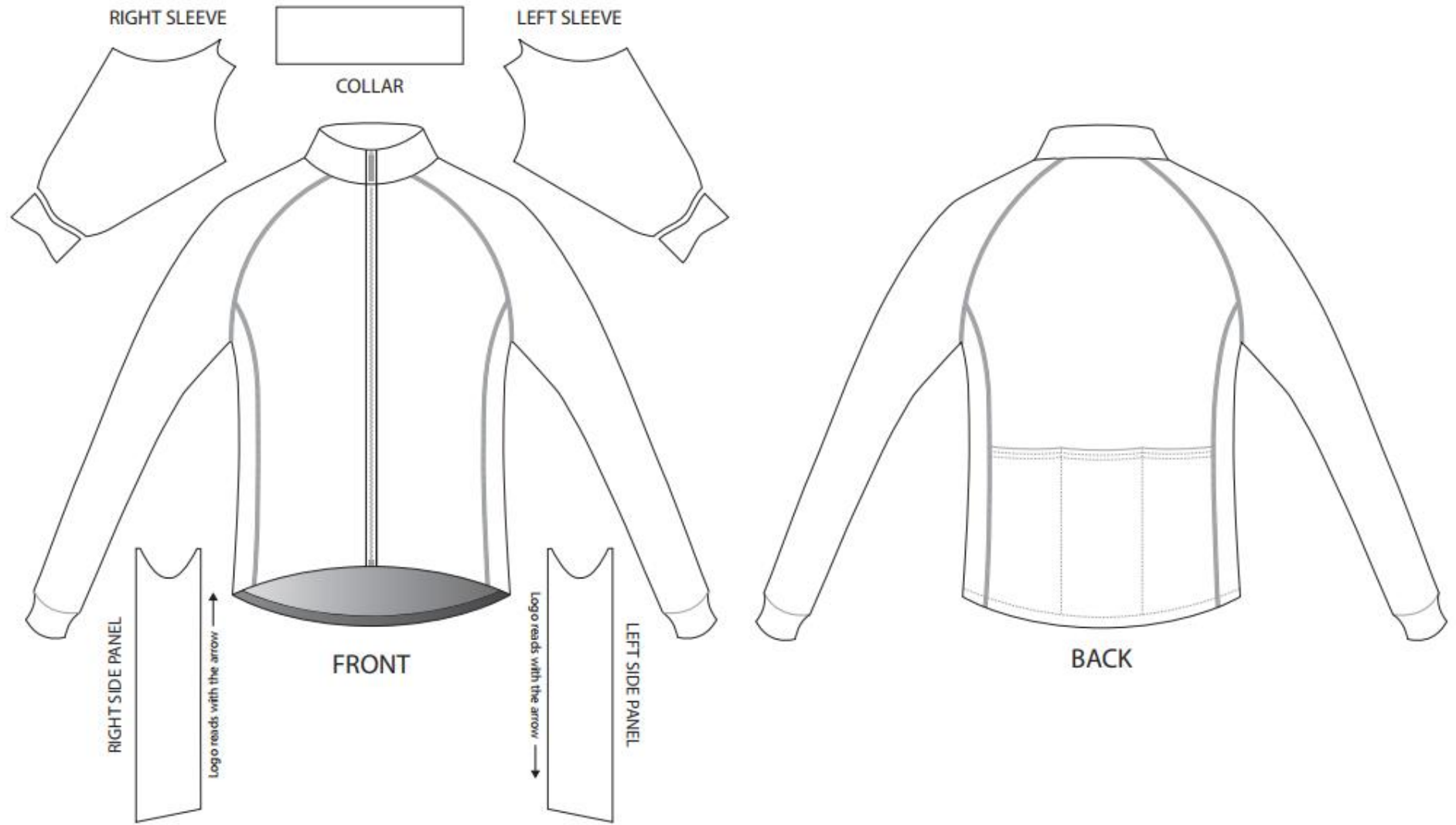

DESIGN TEMPLATE BIB SHORTS

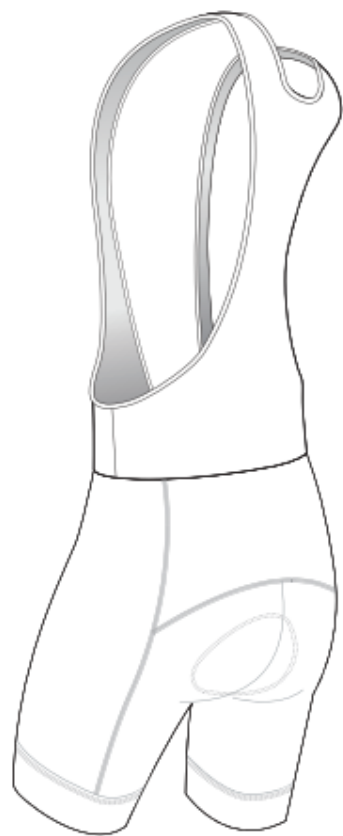

BACK - LEFT



FRONT

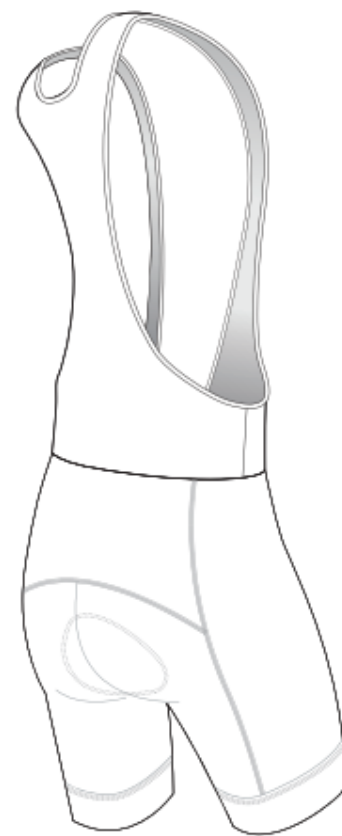

BACK - RIGHT

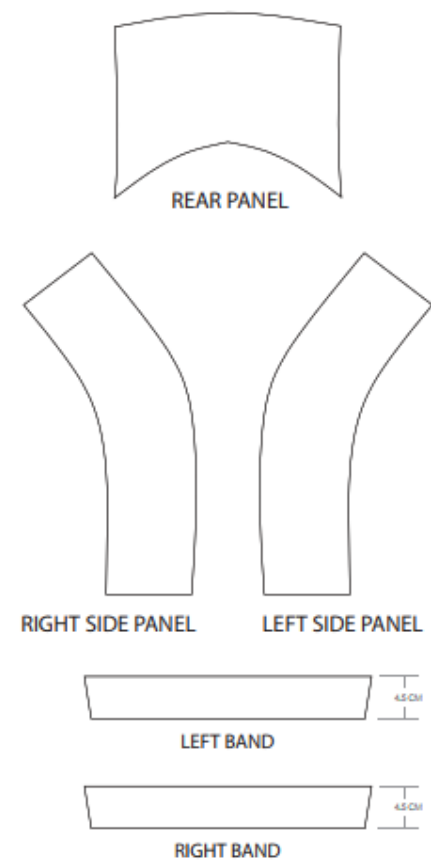

DESIGN TEMPLATE WIND VEST

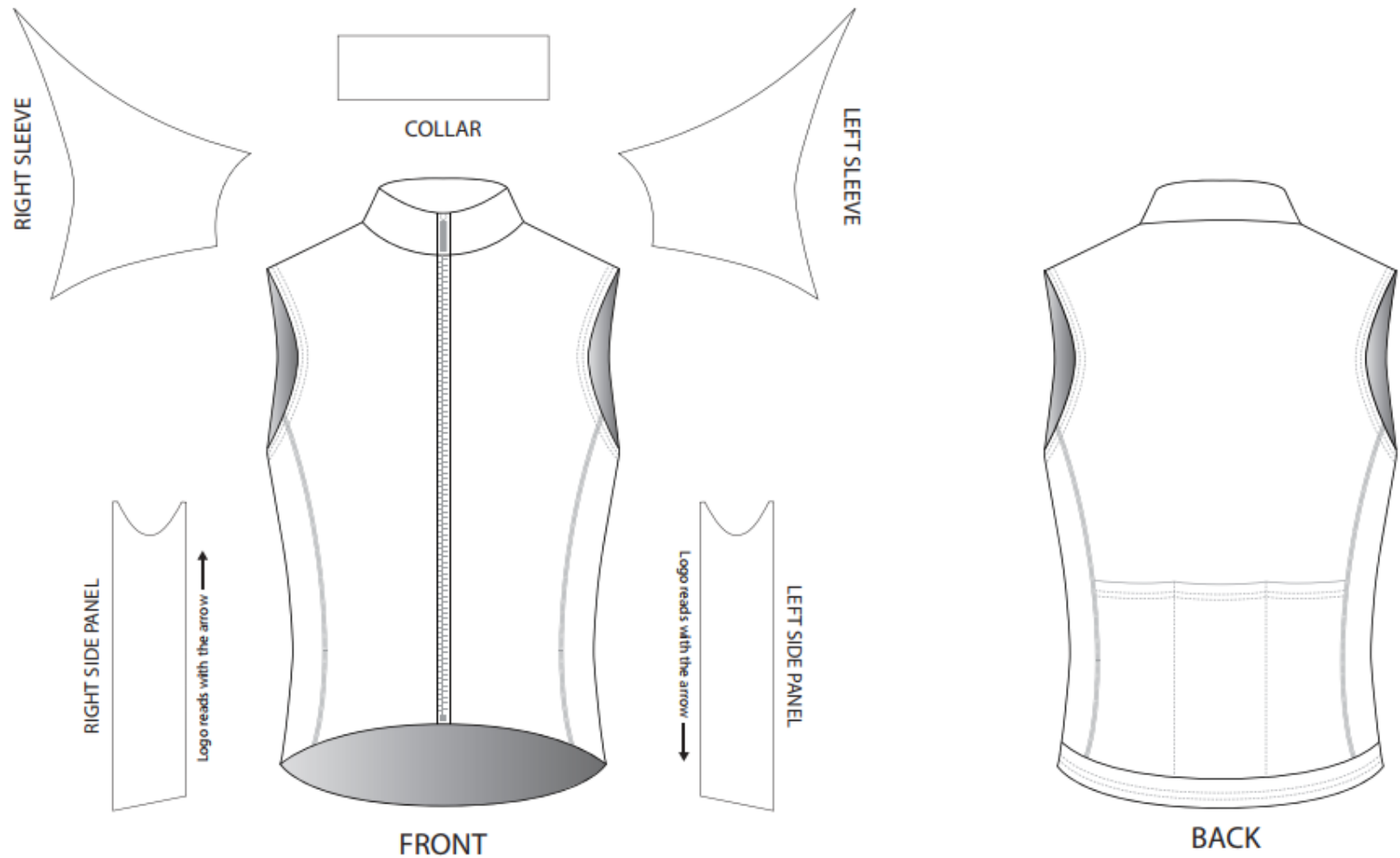

DESIGN TEMPLATE THERMAL JACKET

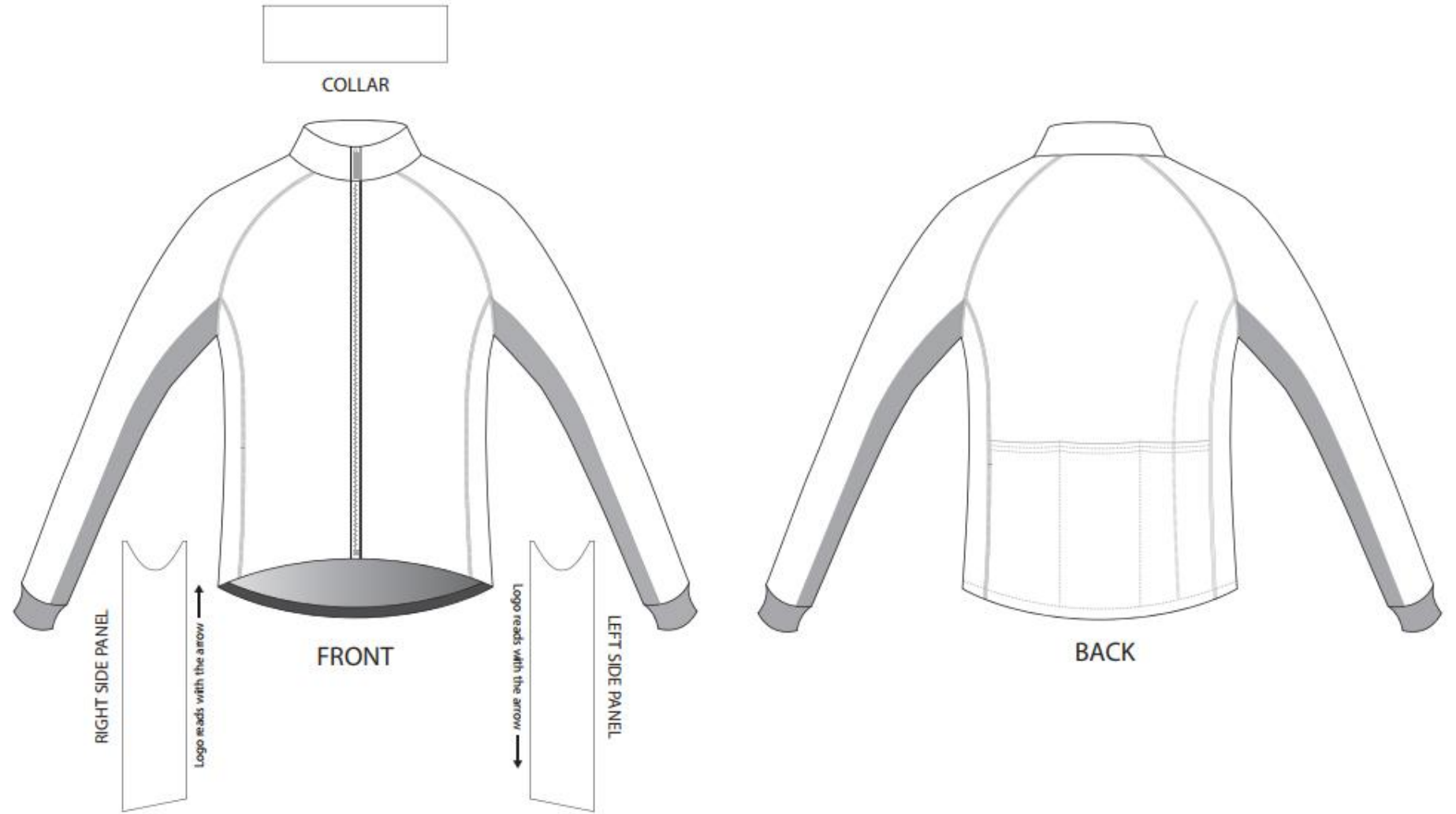

DESIGN TEMPLATE LEG WARMERS

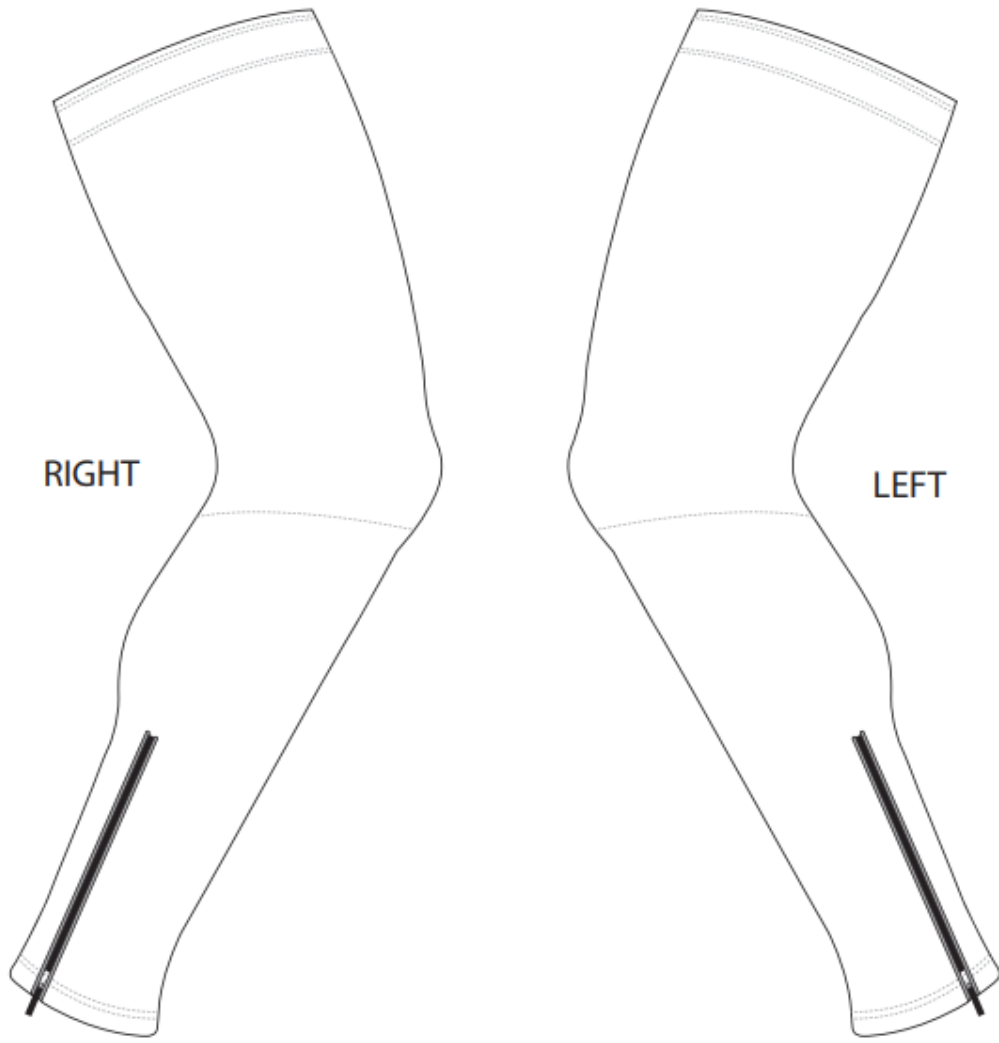

DESIGN TEMPLATE ARM WARMERS

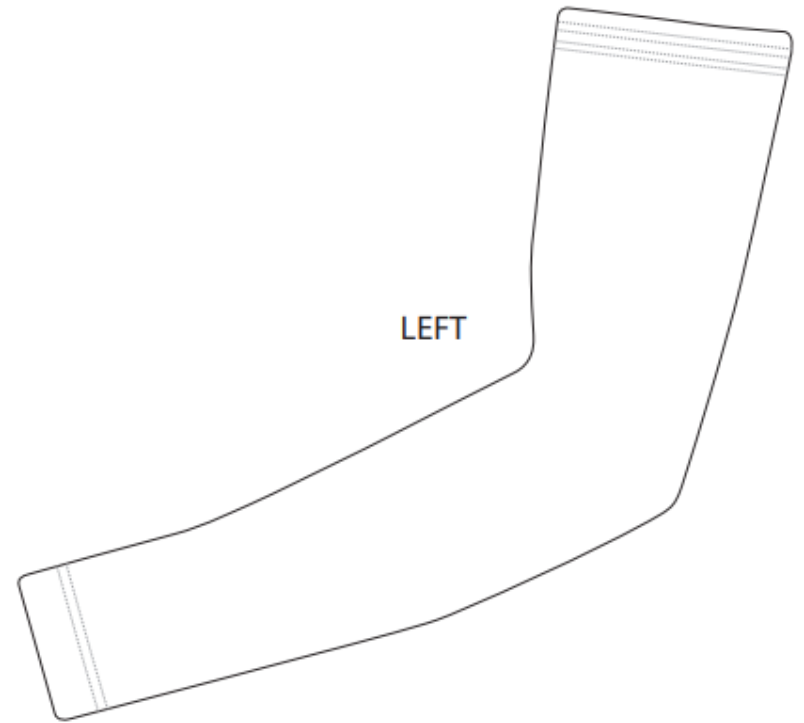
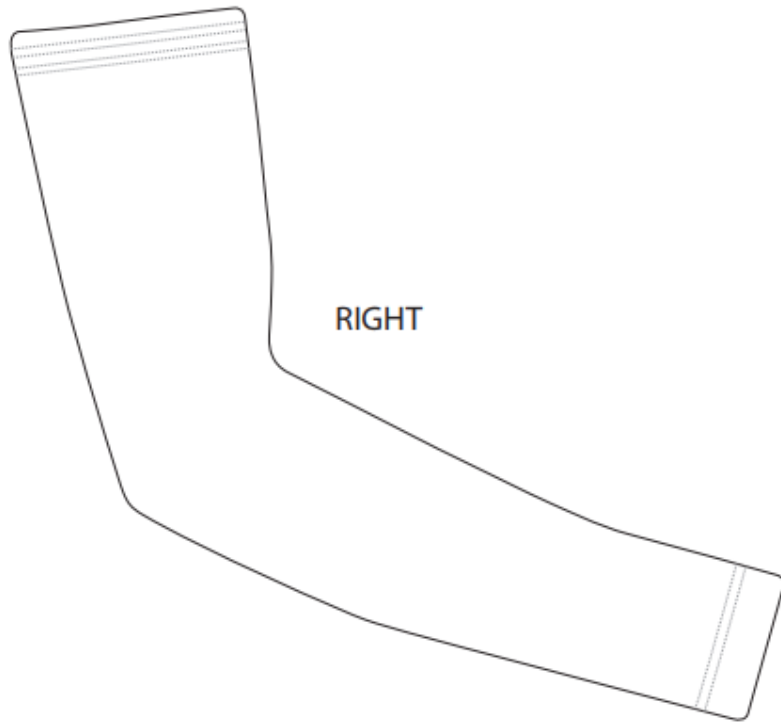





MS
CUSTOM

MS

MS
CUSTOM